

Subject: Place to get good hardware pieces
Posted by [Omar007](#) on Sun, 27 Dec 2009 20:40:13 GMT
[View Forum Message](#) <> [Reply to Message](#)

Well i've been looking into some old PC stuff and found an old 3D shutter glass. ASUS VR100 did i come up with after googling.
I have never used it and i bought it over 6 years ago for €5,-

Now i want it to hook up with my DVI screen so i can get the VSync to control the glasses:

As you see i need a few parts

What is the best place to get them???

With shipping to Netherlands if it's an online shop

I don't want to buy it with 10 or 20 at once. I only need 1 (well maybe 2 just in case)

EDIT: DVI Dongle (pass-through) doesnt has to be ignored. The PSU can

EDIT2: DVI-I not A or D so i have a full pass-through

File Attachments

1) [circuit-big.png](#), downloaded 618 times

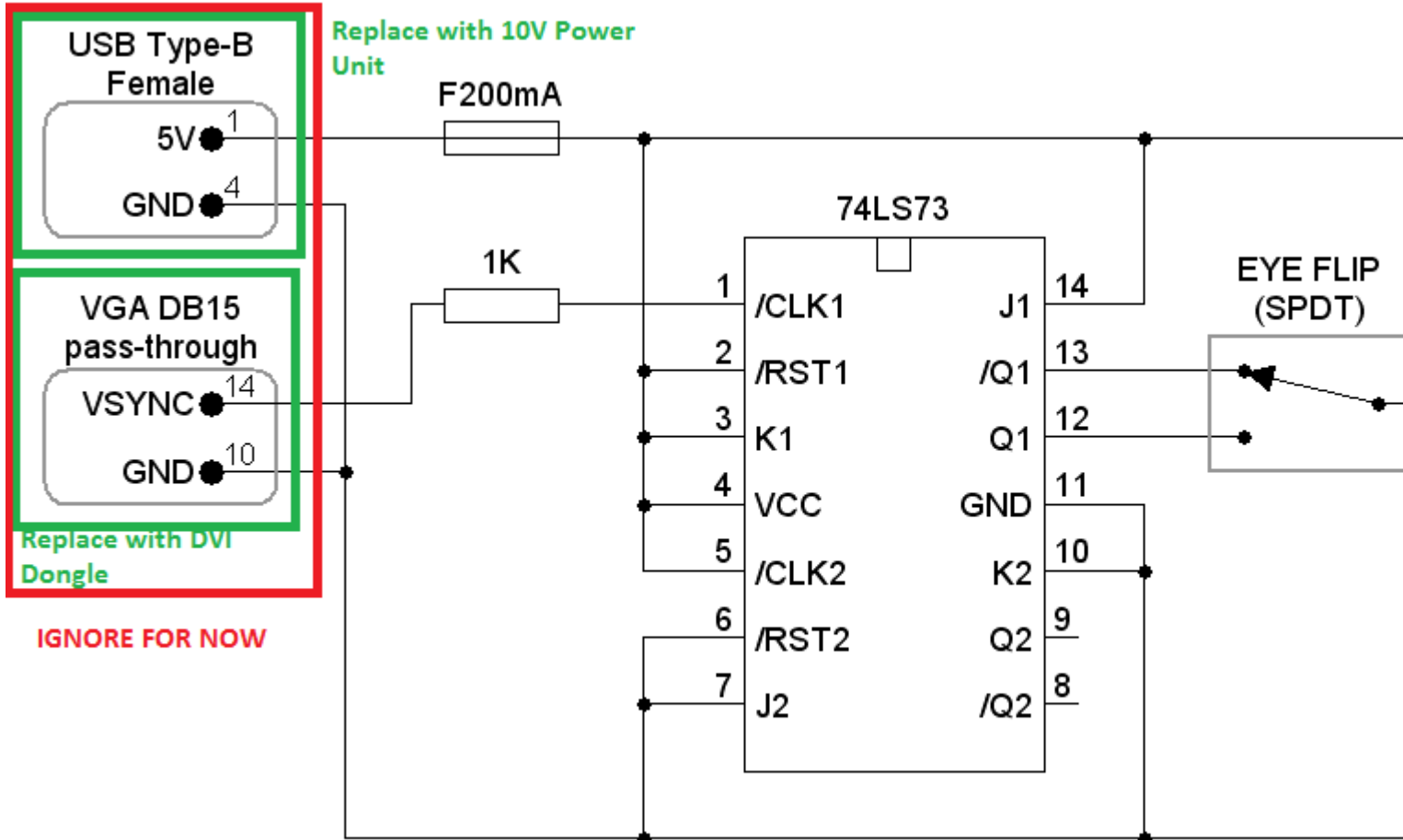

Subject: Re: Place to get good hardware pieces
Posted by [Omar007](#) on Mon, 28 Dec 2009 15:37:08 GMT
[View Forum Message](#) <> [Reply to Message](#)

bump and update

I now only need the 74SL73 chip and a DVI pass-through (or 2 DVI plugs i can solder myself as emergency plan)

I found that the glasses also operate on 9V which i can get from the PC's internal power supply ^^

So the last few things i need in a row:

- * 74LS73 chip
 - * DVI Pass-Through (or loose plugs)
-

Subject: Re: Place to get good hardware pieces
Posted by [luv2pb](#) on Mon, 28 Dec 2009 16:23:52 GMT
[View Forum Message](#) <> [Reply to Message](#)

WE have a place here called "Radio Shack" that actually sells all this crap and at good prices too.

I doubt they have them by you though so really this doesn't help you much.

Subject: Re: Place to get good hardware pieces
Posted by [Omar007](#) on Mon, 28 Dec 2009 16:29:40 GMT
[View Forum Message](#) <> [Reply to Message](#)

I know indeed of radio shack and we dont have it here sadly

I went to 2 electronic shops but 1 didnt even have chips and the other didnt has that chip >.<
They both didnt had DVI stuff...

Subject: Re: Place to get good hardware pieces
Posted by [Goztow](#) on Mon, 28 Dec 2009 19:14:45 GMT
[View Forum Message](#) <> [Reply to Message](#)

I'd try a computer shop (one of the local nerd shops).

Subject: Re: Place to get good hardware pieces
Posted by [dr3w2](#) on Mon, 28 Dec 2009 19:36:35 GMT
[View Forum Message](#) <> [Reply to Message](#)

Not sure if they do international, but a Prof at school was using this for components and what not

<http://www.dealextreme.com/>

Subject: Re: Place to get good hardware pieces
Posted by [Omar007](#) on Mon, 28 Dec 2009 21:03:13 GMT
[View Forum Message](#) <> [Reply to Message](#)

andr3w282 wrote on Mon, 28 December 2009 20:36 Not sure if they do international, but a Prof at school was using this for components and what not

<http://www.dealextreme.com/>

Well they do have a cheap DVI extension cord which i could snap in halve to modify it

And they ship worldwide for free they say ^^

EDIT: Cant seem to find chips. Only replacements for printers etc

UPDATE-EDIT: i found this site for the chip. Anyone heard of it?? I never had;
http://www.littlediode.com/components/74LS73_Integrated_Circuit.html

Subject: Re: Place to get good hardware pieces
Posted by [Doitle](#) on Tue, 29 Dec 2009 02:00:09 GMT
[View Forum Message](#) <> [Reply to Message](#)

RadioShack is insanely expensive for this stuff.

My favorite site:

<http://www.futurlec.com/>

Should have most of what you need. They can be a bit slow to ship but they are in Thailand so that's not too suprising.

<http://www.goldmine-elec.com/>

They are another good site, though a bit more "surplus" in feel. They might have something some weeks and not the next.

<http://www.digikey.com/>

Then there is DigiKey. They are the big name in parts. They will have just about everything ever, but they might be a tad bit more expensive for them. Seriously though anything is going to be cheaper than RadioShack.

I've had good experiences with all three sites. Good luck and if you need any help troubleshooting this thing feel free to send me a PM or post in here.
